

# IRG4PF50WDPbF

INSULATED GATE BIPOLAR TRANSISTOR WITH  
 ULTRAFAST SOFT RECOVERY DIODE

## Features

- Optimized for use in Welding and Switch-Mode Power Supply applications
- Industry benchmark switching losses improve efficiency of all power supply topologies
- 50% reduction of Eoff parameter
- Low IGBT conduction losses
- Latest technology IGBT design offers tighter parameter distribution coupled with exceptional reliability
- IGBT co-packaged with HEXFRED™ ultrafast, ultra-soft-recovery anti-parallel diodes for use in bridge configurations
- Industry standard TO-247AC package
  - Lead-Free

## Benefits

- Lower switching losses allow more cost-effective operation and hence efficient replacement of larger-die MOSFETs up to 100kHz
- HEXFRED™ diodes optimized for performance with IGBTs. Minimized recovery characteristics reduce noise, EMI and switching losses

## Absolute Maximum Ratings

	Parameter	Max.	Units
$V_{CES}$	Collector-to-Emitter Breakdown Voltage	900	V
$I_C @ T_C = 25^\circ\text{C}$	Continuous Collector Current	51	A
$I_C @ T_C = 100^\circ\text{C}$	Continuous Collector Current	28	
$I_{CM}$	Pulsed Collector Current ①	204	
$I_{LM}$	Clamped Inductive Load Current ②	204	
$I_F @ T_C = 100^\circ\text{C}$	Diode Continuous Forward Current	16	
$I_{FM}$	Diode Maximum Forward Current	204	
$V_{GE}$	Gate-to-Emitter Voltage	$\pm 20$	V
$P_D @ T_C = 25^\circ\text{C}$	Maximum Power Dissipation	200	W
$P_D @ T_C = 100^\circ\text{C}$	Maximum Power Dissipation	78	
$T_J$	Operating Junction and	-55 to + 150	°C
$T_{STG}$	Storage Temperature Range		
	Soldering Temperature, for 10 seconds	300 (0.063 in. (1.6mm) from case )	
	Mounting torque, 6-32 or M3 screw.	10 lbf·in (1.1N·m)	

## Thermal Resistance

	Parameter	Min.	Typ.	Max.	Units
$R_{\theta JC}$	Junction-to-Case - IGBT	—	—	0.64	°C/W
$R_{\theta JC}$	Junction-to-Case - Diode	—	—	0.83	
$R_{\theta CS}$	Case-to-Sink, flat, greased surface	—	0.24	—	
$R_{\theta JA}$	Junction-to-Ambient, typical socket mount	—	—	40	
$Wt$	Weight	—	6 (0.21)	—	g (oz)

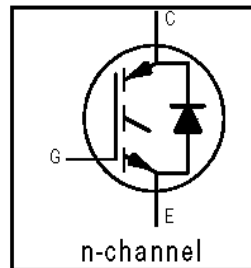

$V_{CES} = 900\text{V}$
$V_{CE(on)} \text{ typ.} = 2.25\text{V}$
@ $V_{GE} = 15\text{V}, I_C = 28\text{A}$

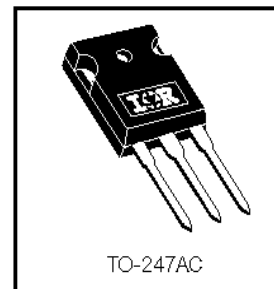

# IRG4PF50WDPbF

International  
IR Rectifier

## Electrical Characteristics @ $T_J = 25^\circ\text{C}$ (unless otherwise specified)

	Parameter	Min.	Typ.	Max.	Units	Conditions
$V_{(BR)CES}$	Collector-to-Emitter Breakdown Voltage <sup>③</sup>	900	—	—	V	$V_{GE} = 0V, I_C = 250\mu A$
$\Delta V_{(BR)CES}/\Delta T_J$	Temperature Coeff. of Breakdown Voltage	—	0.295	—	V/°C	$V_{GE} = 0V, I_C = 3.5mA$
$V_{CE(on)}$	Collector-to-Emitter Saturation Voltage	—	2.25	2.7	V	$I_C = 28A, V_{GE} = 15V$
		—	2.74	—		$I_C = 60A$ See Fig. 2, 5
		—	2.12	—		$I_C = 28A, T_J = 150^\circ\text{C}$
$V_{GE(th)}$	Gate Threshold Voltage	3.0	—	6.0		$V_{CE} = V_{GE}, I_C = 250\mu A$
$\Delta V_{GE(th)}/\Delta T_J$	Temperature Coeff. of Threshold Voltage	—	-13	—	mV/°C	$V_{CE} = V_{GE}, I_C = 250\mu A$
$g_{fe}$	Forward Transconductance <sup>④</sup>	26	39	—	S	$V_{CE} = 50V, I_C = 28A$
$I_{CES}$	Zero Gate Voltage Collector Current	—	—	500	$\mu A$	$V_{GE} = 0V, V_{CE} = 900V$
		—	—	2.0		$V_{GE} = 0V, V_{CE} = 10V, T_J = 25^\circ\text{C}$
		—	—	6.5	mA	$V_{GE} = 0V, V_{CE} = 900V, T_J = 150^\circ\text{C}$
$V_{FM}$	Diode Forward Voltage Drop	—	2.5	3.5	V	$I_C = 16A$ See Fig. 13
		—	2.1	3.0		$I_C = 16A, T_J = 150^\circ\text{C}$
$I_{GES}$	Gate-to-Emitter Leakage Current	—	—	$\pm 100$	nA	$V_{GE} = \pm 20V$

## Switching Characteristics @ $T_J = 25^\circ\text{C}$ (unless otherwise specified)

	Parameter	Min.	Typ.	Max.	Units	Conditions
$Q_g$	Total Gate Charge (turn-on)	—	160	240	nC	$I_C = 28A, V_{CC} = 400V$ See Fig. 8 $V_{GE} = 15V$
$Q_{ge}$	Gate - Emitter Charge (turn-on)	—	19	29		
$Q_{gc}$	Gate - Collector Charge (turn-on)	—	53	80		
$t_{d(on)}$	Turn-On Delay Time	—	71	—	ns	$T_J = 25^\circ\text{C}$ $I_C = 28A, V_{CC} = 720V$ $V_{GE} = 15V, R_G = 5.0\Omega$ Energy losses include "tail" and diode reverse recovery.
$t_r$	Rise Time	—	50	—		
$t_{d(off)}$	Turn-Off Delay Time	—	150	220		
$t_f$	Fall Time	—	110	170	mJ	See Fig. 9, 10, 18
$E_{on}$	Turn-On Switching Loss	—	2.63	—		
$E_{off}$	Turn-Off Switching Loss	—	1.34	—		
$E_{ts}$	Total Switching Loss	—	3.97	5.3	ns	$T_J = 150^\circ\text{C}$ , See Fig. 11, 18 $I_C = 28A, V_{CC} = 720V$ $V_{GE} = 15V, R_G = 5.0\Omega$ Energy losses include "tail" and diode reverse recovery.
$t_{d(on)}$	Turn-On Delay Time	—	69	—		
$t_r$	Rise Time	—	52	—		
$t_{d(off)}$	Turn-Off Delay Time	—	270	—	mJ	Measured 5mm from package
$t_f$	Fall Time	—	190	—		
$E_{ts}$	Total Switching Loss	—	6.0	—		
$L_E$	Internal Emitter Inductance	—	13	—	nH	
$C_{ies}$	Input Capacitance	—	3300	—	pF	$V_{GE} = 0V, V_{CC} = 30V$ See Fig. 7 $f = 1.0MHz$
$C_{oes}$	Output Capacitance	—	200	—		
$C_{res}$	Reverse Transfer Capacitance	—	45	—		
$t_{rr}$	Diode Reverse Recovery Time	—	90	135	ns	$T_J = 25^\circ\text{C}$ See Fig. 14 $T_J = 125^\circ\text{C}$ 14
		—	164	245		
$I_{rr}$	Diode Peak Reverse Recovery Current	—	5.8	10	A	$T_J = 25^\circ\text{C}$ See Fig. 15 $T_J = 125^\circ\text{C}$ 15
		—	8.3	15		
$Q_{rr}$	Diode Reverse Recovery Charge	—	260	675	nC	$T_J = 25^\circ\text{C}$ See Fig. 16 $T_J = 125^\circ\text{C}$ 16
		—	680	1838		
$di_{(rec)M}/dt$	Diode Peak Rate of Fall of Recovery During $t_b$	—	120	—	A/ $\mu s$	$T_J = 25^\circ\text{C}$ See Fig. 17 $T_J = 125^\circ\text{C}$ 17
		—	76	—		

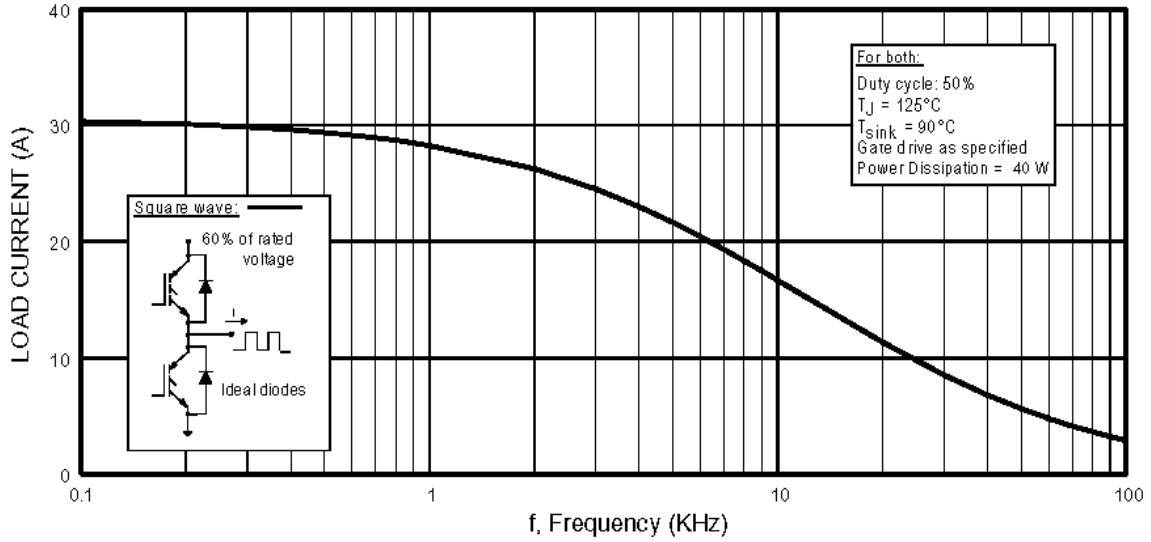

**Fig. 1** - Typical Load Current vs. Frequency  
 (Load Current =  $I_{\text{RMS}}$  of fundamental)

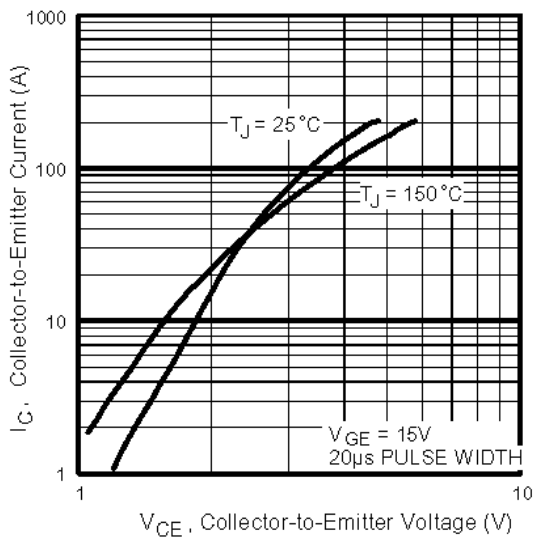

**Fig. 2** - Typical Output Characteristics  
[www.irf.com](http://www.irf.com)

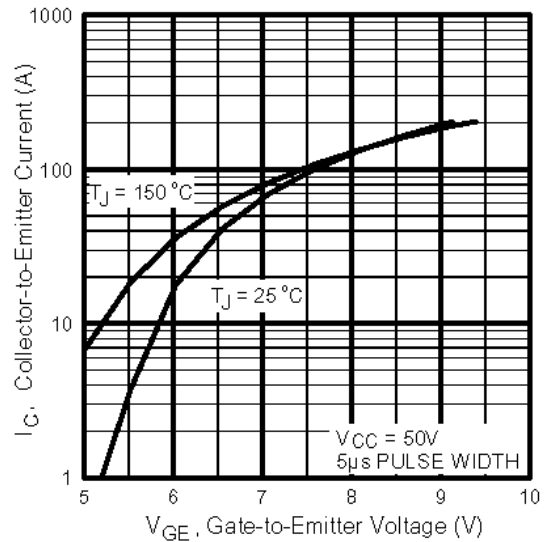

**Fig. 3** - Typical Transfer Characteristics

# IRG4PF50WDPbF

International  
**IR** Rectifier

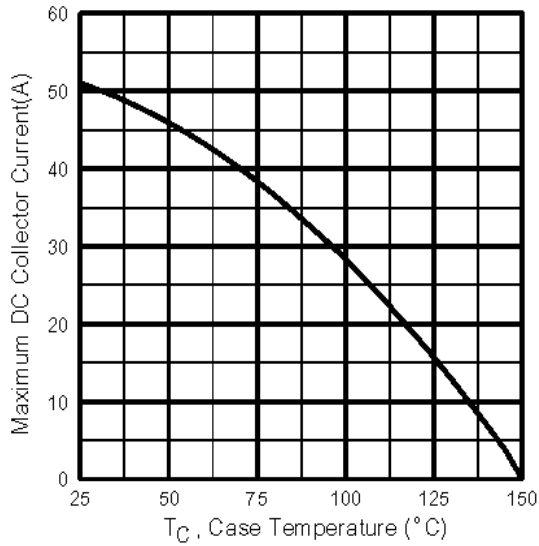

**Fig. 4** - Maximum Collector Current vs. Case Temperature

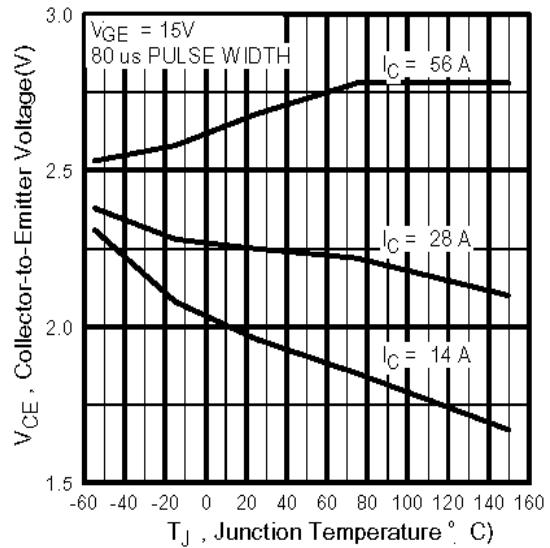

**Fig. 5** - Collector-to-Emitter Voltage vs. Junction Temperature

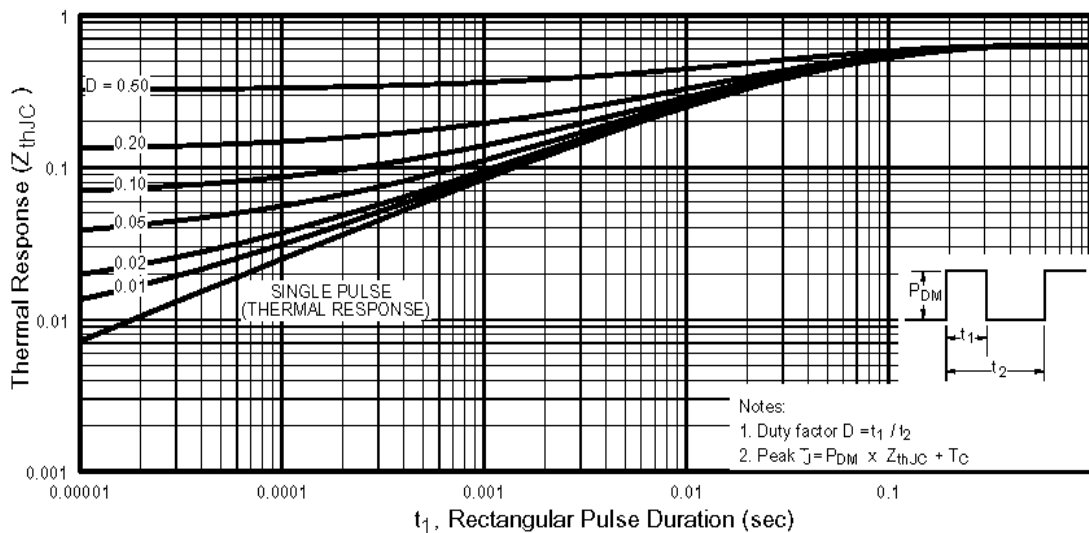

**Fig. 6** - Maximum Effective Transient Thermal Impedance, Junction-to-Case

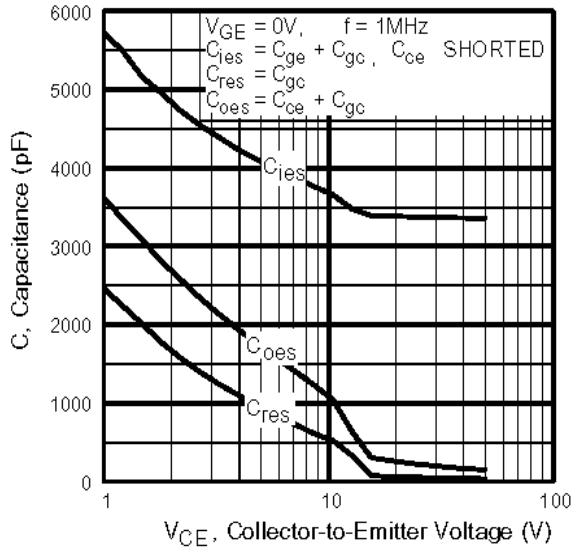

**Fig. 7** - Typical Capacitance vs. Collector-to-Emitter Voltage

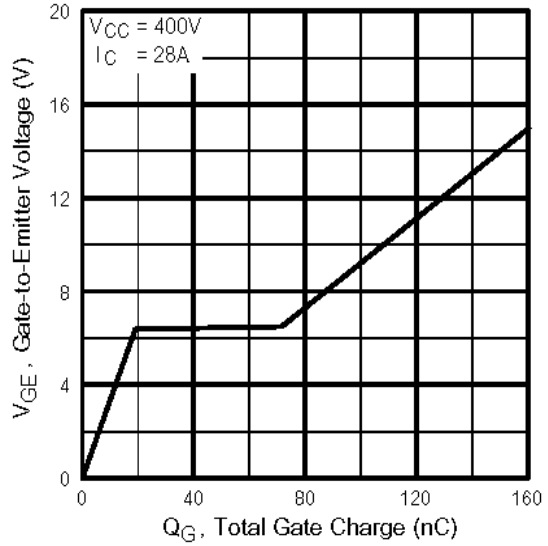

**Fig. 8** - Typical Gate Charge vs. Gate-to-Emitter Voltage

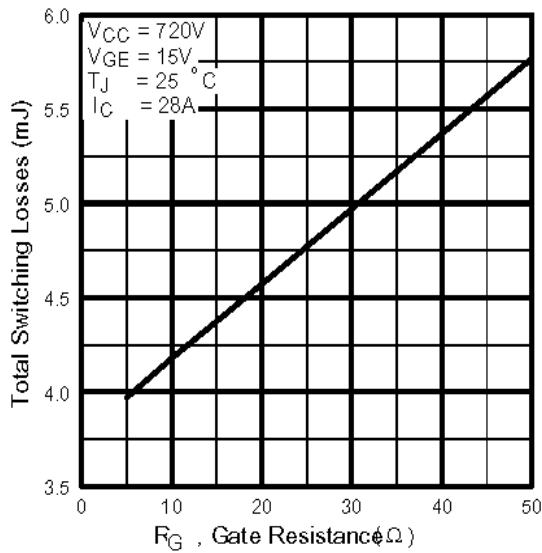

**Fig. 9** - Typical Switching Losses vs. Gate Resistance

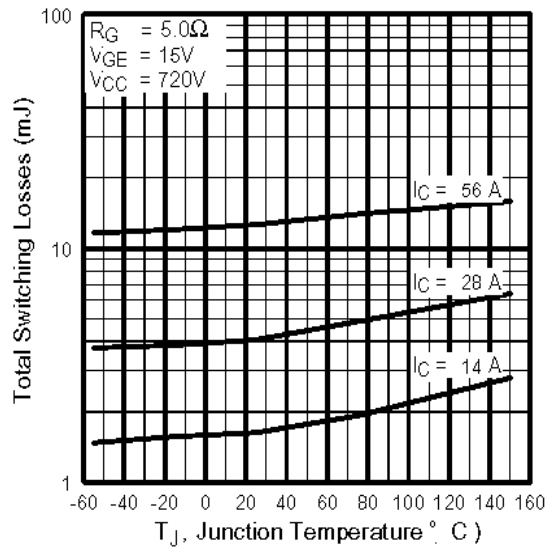

**Fig. 10** - Typical Switching Losses vs. Junction Temperature

# IRG4PF50WDPbF

International  
**IR** Rectifier

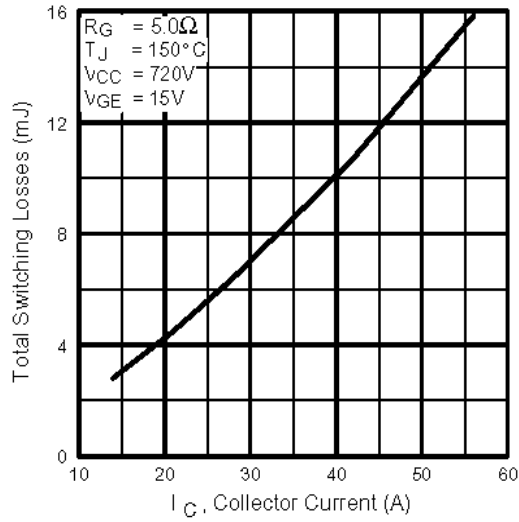

**Fig. 11** - Typical Switching Losses vs. Collector-to-Emitter Current

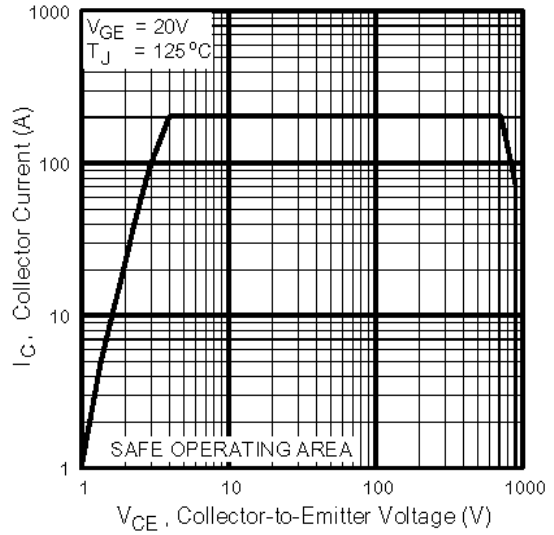

**Fig. 12** - Turn-Off SOA

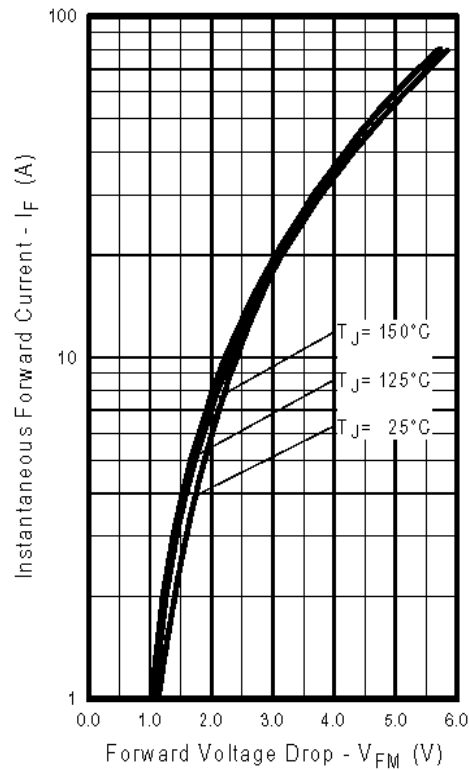

**Fig. 13** - Typical Forward Voltage Drop vs. Instantaneous Forward Current

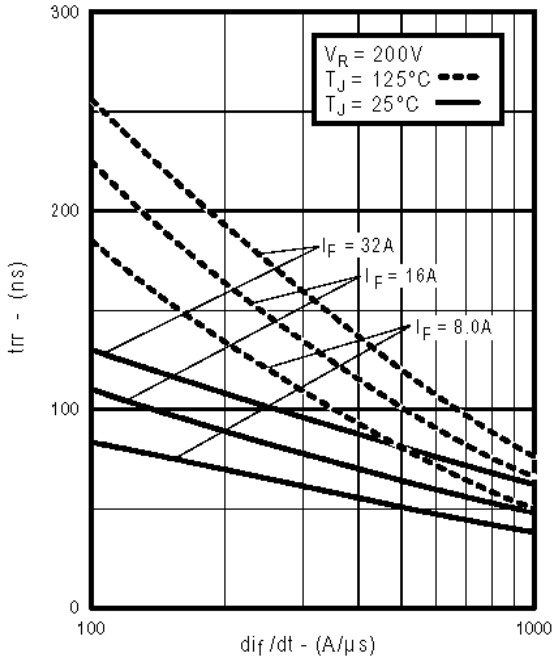

Fig. 14 - Typical Reverse Recovery vs.  $di_f/dt$

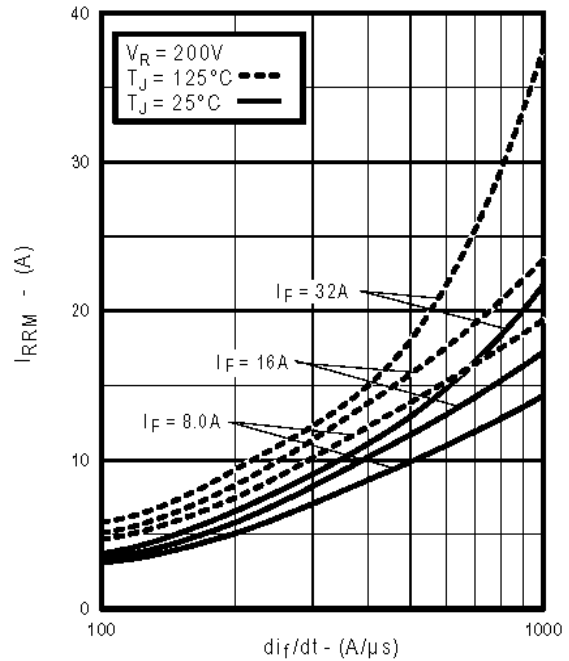

Fig. 15 - Typical Recovery Current vs.  $di_f/dt$

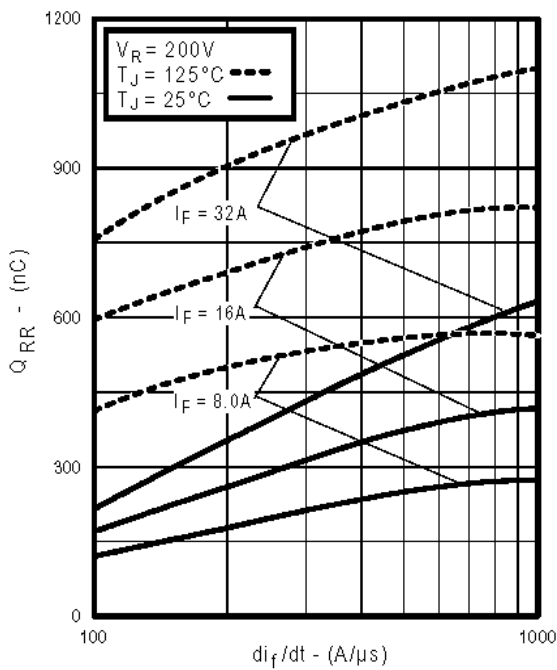

Fig. 16 - Typical Stored Charge vs.  $di_f/dt$   
www.irf.com

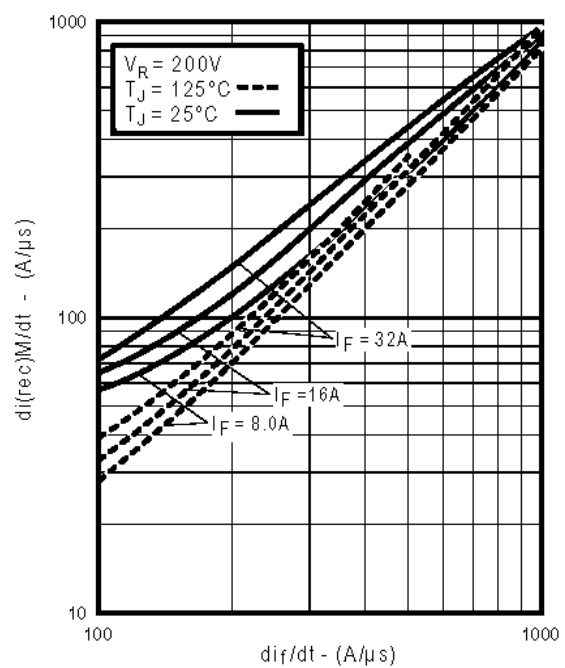
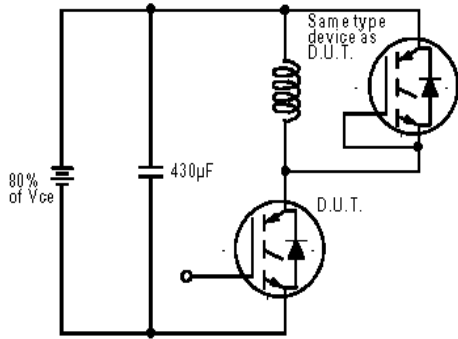

Fig. 17 - Typical  $di_{(rec)M}/dt$  vs.  $di_f/dt$

# IRG4PF50WDPbF

International  
**IR** Rectifier



**Fig. 18a** - Test Circuit for Measurement of  $I_{LM}$ ,  $E_{on}$ ,  $E_{off}(\text{diode})$ ,  $t_{rr}$ ,  $Q_{rr}$ ,  $I_{rr}$ ,  $t_{d(on)}$ ,  $t_r$ ,  $t_{d(off)}$ ,  $t_f$

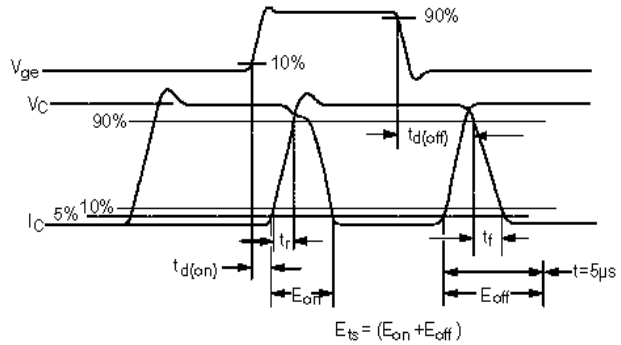

**Fig. 18b** - Test Waveforms for Circuit of Fig. 18a, Defining  $E_{off}$ ,  $t_{d(off)}$ ,  $t_f$

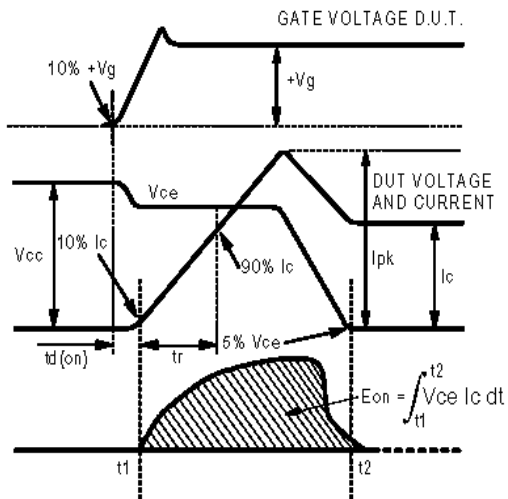

**Fig. 18c** - Test Waveforms for Circuit of Fig. 18a, Defining  $E_{on}$ ,  $t_{d(on)}$ ,  $t_r$

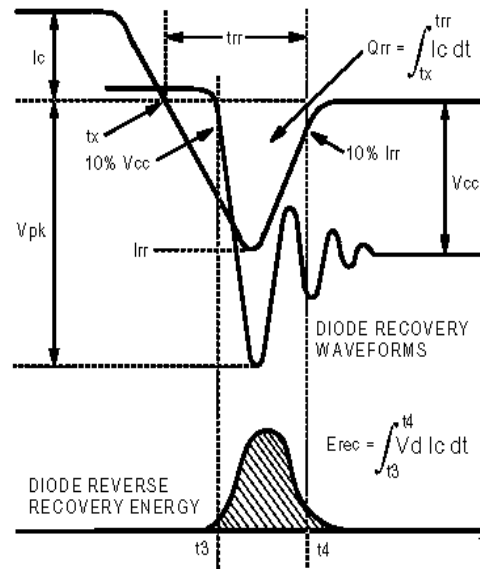

**Fig. 18d** - Test Waveforms for Circuit of Fig. 18a, Defining  $E_{rec}$ ,  $t_{rr}$ ,  $Q_{rr}$ ,  $I_{rr}$



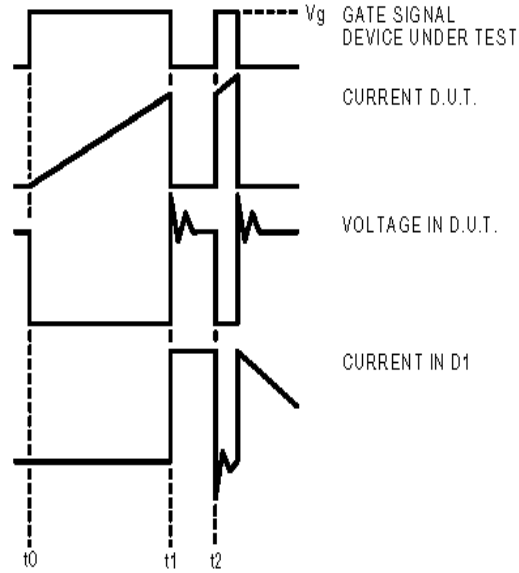

Figure 18e. Macro Waveforms for Figure 18a's Test Circuit

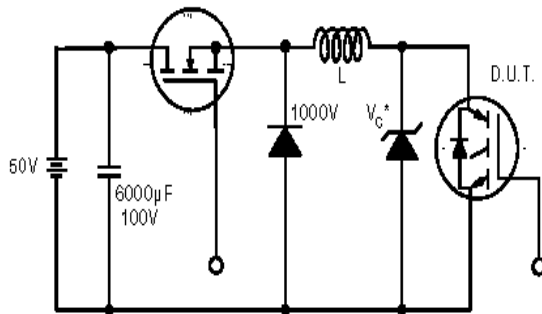

Figure 19. Clamped Inductive Load Test Circuit

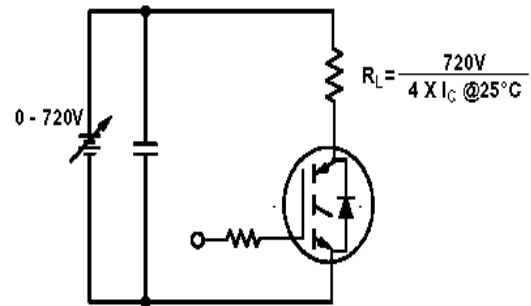

Figure 20. Pulsed Collector Current Test Circuit

# IRG4PF50WDPbF

International  
**IR** Rectifier

## TO-247AC Package Outline

Dimensions are shown in millimeters (inches)

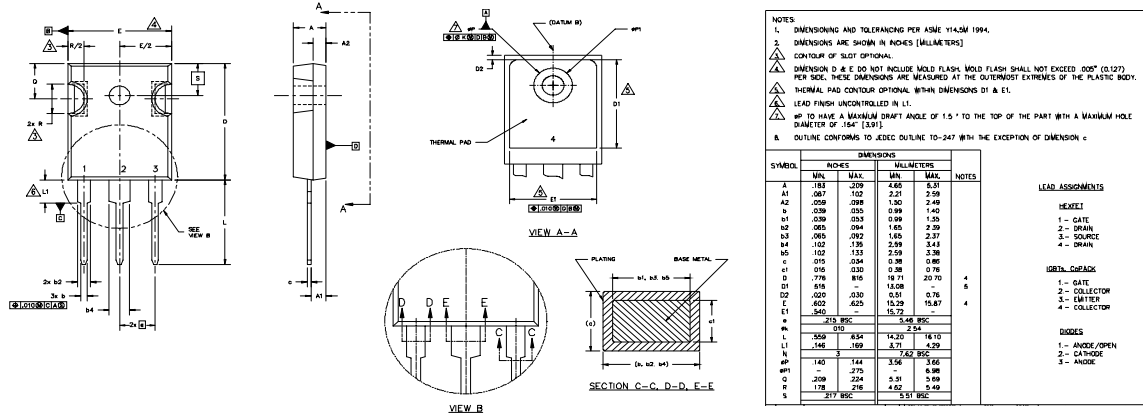

## TO-247AC Part Marking Information

EXAMPLE: THIS IS AN IRFPE30  
WITH ASSEMBLY  
LOT CODE 5657  
ASSEMBLED ON WW 35, 2000  
IN THE ASSEMBLY LINE "H"

**Note:** "P" in assembly line position indicates "Lead-Free"

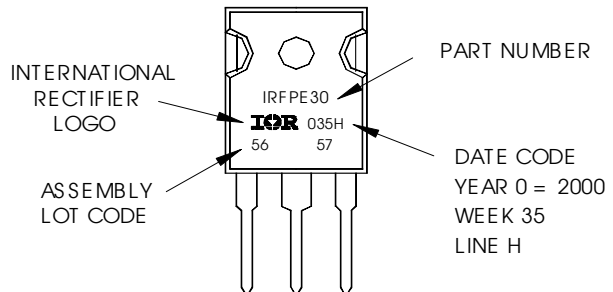

Data and specifications subject to change without notice.

International  
**IR** Rectifier

IR WORLD HEADQUARTERS: 233 Kansas St., El Segundo, California 90245, USA Tel: (310) 252-7105  
TAC Fax: (310) 252-7903

Visit us at [www.irf.com](http://www.irf.com) for sales contact information. 04/04

[www.irf.com](http://www.irf.com)